

Department of Commerce (CA)

CORE PAPER-II-DATABASE SYSTEM CONCEPTS

SEMESTER:I

SUB CODE: 18MCC12C

M.COM(CA)

UNIT5: Network approach-architecture of DBTG system-DBTG data structure-the set construct-singular sets-sample schema-the external level of DBTG-DBTG data manipulation.

REFERENCE BOOK:

An introduction to database system-C.J. Dates

An introduction to database system-Bipin

PREPARED BY: DR. E.N. KANJANA,

ASST PROFESSOR.



Basic Concepts

- Data are represented by collections of *records*.
 - similar to an entity in the E-R model
 - Records and their fields are represented as *record type*

```
type customer = record
customer-name: string;
customer-street: string;
customer-city: string;
end
type account = record
account-number: integer;
balance: integer;
end
```

- Relationships among data are represented by *links*
 - similar to a restricted (binary) form of an E-R relationship
 - restrictions on links depend on whether the relationship is many-many, many-to-one, or one-to-one.



Data-Structure Diagrams

- Schema representing the design of a network database.
- A data-structure diagram consists of two basic components:
 - **Boxes**, which correspond to record types.
 - **Lines**, which correspond to links.
- Specifies the overall logical structure of the database.





Data-Structure Diagrams (Cont.)

- For every E-R diagram, there is a corresponding data-structure diagram.

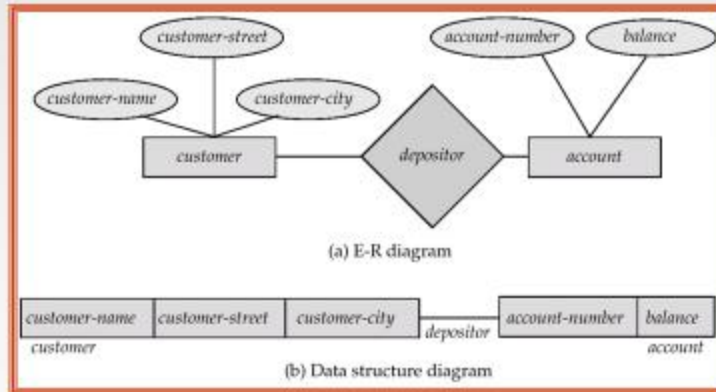

Data-Structure Diagrams (Cont.)

- Since a link cannot contain any data value, represent an E-R relationship with attributes with a new record type and links.

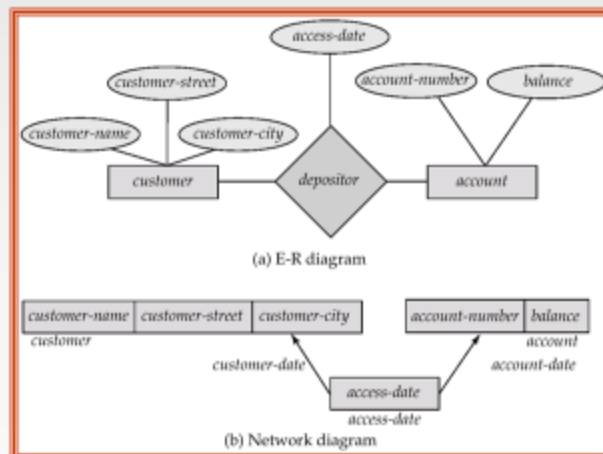



General Relationships

- To represent an E-R relationship of degree 3 or higher, connect the participating record types through a new record type that is linked directly to each of the original record types.
1. Replace entity sets *account*, *customer*, and *branch* with record types *account*, *customer*, and *branch*, respectively.
 2. Create a new record type *Rlink* (referred to as a *dummy* record type).
 3. Create the following many-to-one links:
 - *CustRlink* from *Rlink* record type to *customer* record type
 - *AcctRlink* from *Rlink* record type to *account* record type
 - *BrncRlink* from *Rlink* record type to *branch* record type



Network Representation of Ternary Relationship

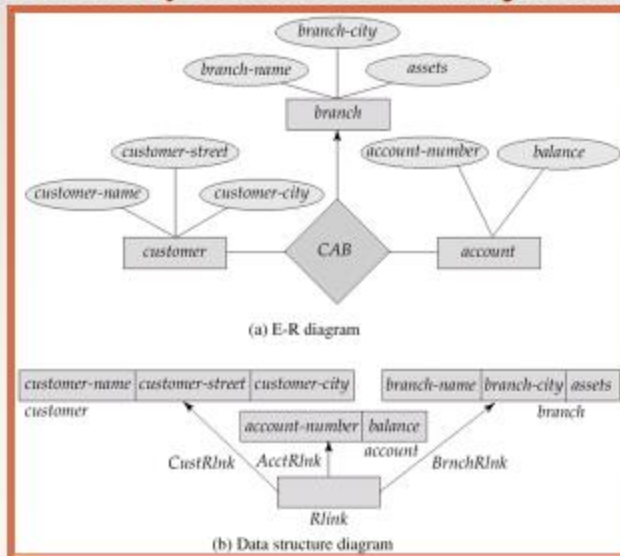



The DBTG CODASYL Model

- All links are treated as many-to-one relationships.
- To model many-to-many relationships, a record type is defined to represent the relationship and two links are used.

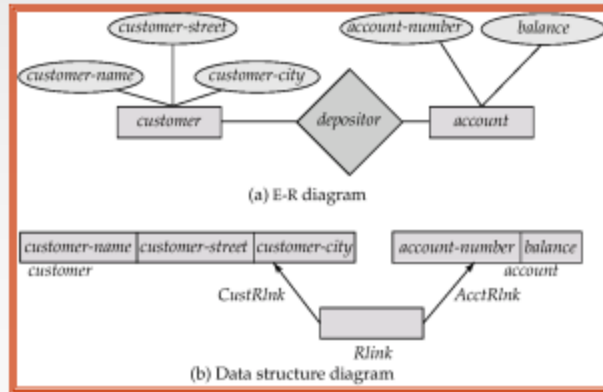

DBTG Sets

- The structure consisting of two record types that are linked together is referred to in the DBTG model as a *DBTG set*
- In each DBTG set, one record type is designated as the *owner*, and the other is designated as the *member*, of the set.
- Each DBTG set can have any number of *set occurrences* (actual instances of linked records).
- Since many-to-many links are disallowed, each set occurrence has precisely one owner, and has zero or more member records.
- No member record of a set can participate in more than one occurrence of the set at any point.
- A member record can participate simultaneously in several set occurrences of *different* DBTG sets.





Repeating Groups

- Provide a mechanism for a field to have a set of values rather than a single value.
- Alternative representation of weak entities from the E-R model
- Example: Two sets.
 - *customer* (*customer-name*)
 - *customer-address* (*customer-street*, *customer-city*)
- The following diagrams represent these sets without the repeating-group construct.



Repeating Groups (Cont.)

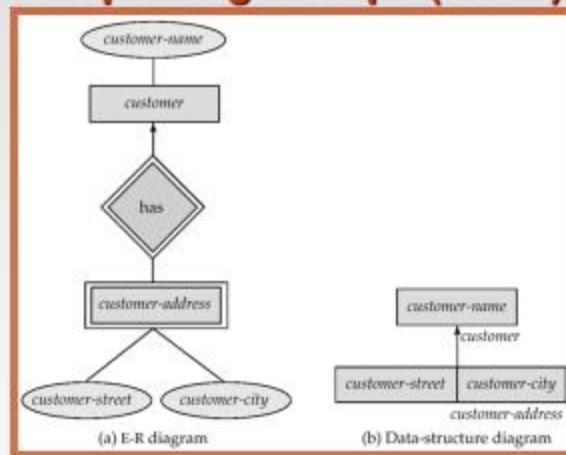

- With the repeating-group construct, the data-structure diagram consists of the single record type *customer*.



DBTG Data-Retrieval Facility

- The DBTG data manipulation language consists of a number of commands that are embedded in a host language.
- *Run unit* — system application program consisting of a sequence of host language and DBTG command statements. Statements access and manipulate database items as well as locally declared variables.
- *Program work-area (or user work area)* — a buffer storage area the system maintains for each application program



DBTG Variables

- Record Templates
- Currency pointers
 - Current of record type
 - Current of set type
 - Current of run unit
- Status flags
 - **DB-status** is most frequently used
 - Additional variables: **DB-set-name**, **DB-record-name**, and **DB-data-name**





Example Schema

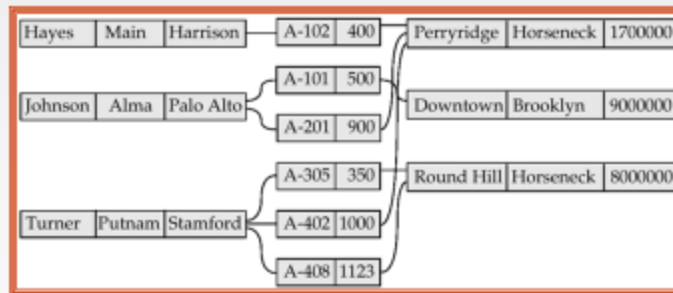
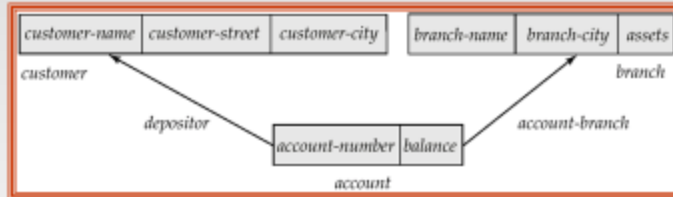

Example Program Work Area

- Templates for three record types: *customer*, *account*, and *branch*.
- Six currency pointers
 - Three pointers for record types: one each to the most recently accessed *customer*, *account*, and *branch* record
 - Two pointers for set types: one to the most recently accessed record in an occurrence of the set *depositor*, one to the most recently accessed record in an occurrence of the set *account-branch*
 - One run-unit pointer.
- Status flags: four variables defined previously
- Following diagram shows an example program work area state.



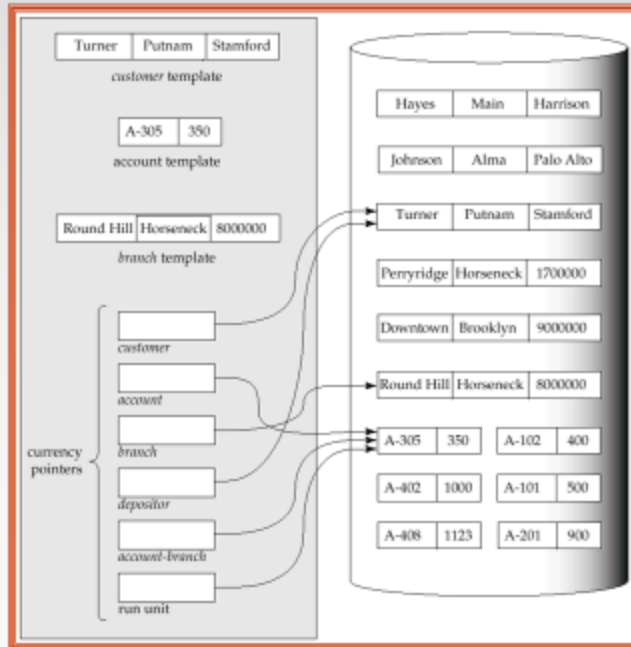

The Find and Get Commands

- **find** locates a record in the database and sets the appropriate currency pointers
- **get** copies of the record to which the current of run-unit points from the database to the appropriate program work area template
- Example: Executing a **find** command to locate the customer record belonging to Johnson causes the following changes to occur in the state of the program work area.
 - The current of the record type *customer* now points to the record of Johnson.
 - The current of set type *depositor* now points to the set owned by Johnson
 - The current of run unit now points to *customer* record Johnson.





Access of Individual Records

- **find any** <record type> **using** <record-field>
Locates a record of type <record type> whose <record-field> value is the same as the value of <record-field> in the <record type> template in the program work area.
- Once such a record is found, the following currency pointers are set to point to that record:
 - The current of run-unit pointer
 - The record-type currency pointer for <record type>
 - For each set in which that record belongs, the appropriate set currency pointer
- **find duplicate** <record type> **using** <record-field>
Locates (according to a system-dependent ordering) the next record that matches the <record-field>



Access of Records Within a Set

- Other **find** commands locate records in the DBTG set that is pointed to by the <set-type> currency pointer.
- **find first** <record type> **within** <set-type>
Locates the first database record of type <record type> belonging to the current <set-type>.
- To locate the other members of a set, we use

find next <record type> **within** <set-type>

which finds the next element in the set <set-type>.

- **find owner within** <set-type>
Locates the owner of a particular DBTG set





Predicates

- For queries in which a field value must be matched with a specified range of values, rather than to only one, we need to:
 - **get** the appropriate records into memory
 - examine each one separately for a match
 - determine whether each is the target of our **find** statement



Example DBTG Query

- Print the total number of accounts in the Perryridge branch with a balance greater than \$10,000.

```
count := 0;
branch.branch-name := "Perryridge";
find any branch using branch-name;
find first account within account-branch;
while DB-status = 0 do
  begin
    get account
    if account.balance > 10000 then count := count + 1;
    find next account within account-branch;
  end
print (count);
```





DBTG Update Facility

- DBTG mechanisms are available to update information in the database.
- To create a new record of type <record type>
 - insert the appropriate values in the corresponding <record type> template
 - add this new record to the database by executing
store <record type>
- Can create and add new records only one at a time



DBTG Update Facility (Cont.)

- To modify an existing record of type <record type>
 - find that record in the database
 - get that record into memory
 - change the desired fields in the template of <record type>
 - reflect the changes to the record to which the currency point of <record type> points by executing
modify <record type>





DBTG Update Facility (Cont.)

- To delete an existing record of type <record type>
 - make the currency pointer of that type point to the record in the database to be deleted
 - delete that record by executing

erase <record type>

- Delete an entire set occurrence by finding the owner of the set and executing

erase all <record type>

- Deletes the owner of the set, as well as all the set's members.
- If a member of the set is an owner of another set, the members of that second set also will be deleted.
- **erase all** is recursive.



DBTG Set-Processing Facility

- Mechanisms are provided for inserting records into and removing records from a particular set occurrence
- Insert a new record into a set by executing the **connect** statement.
connect <record type> **to** <set-type>
- Remove a record from a set by executing the **disconnect** statement.
disconnect <record type> **from** <set-type>





Example disconnect Query

- Close account A-201, that is, delete the relationship between account A-201 and its customer, but archive the record of account A-201.
- The following program removes account A-201 from the set occurrence of type *depositor*. The account will still be accessible in the database for record-keeping purposes.

```
account.account-number := "A-201";  
find for update any account using account-number.  
get account,  
find owner within depositor,  
disconnect account from depositor.
```



DBTG Set-Processing Facility (Cont.)

- To move a record of type <record type> from one set occurrence to another set occurrence of type <set-type>
 - Find the appropriate record and the owner of the set occurrences to which that record is to be moved.
 - Move the record by executing

```
reconnect <record type> to <set-type>
```

- Example: Move all accounts of Hayes that are currently at the Perryridge branch to the Downtown branch.





Example reconnect Query

```
customer.customer-name := "Hayes";  
find any customer using customer-name;  
find first account within depositor;  
while DB-status = 0 do  
  begin  
    find owner within account-branch;  
    get branch;  
    if branch.branch-name = "Perryridge" then  
      begin  
        branch.branch-name := "Downtown";  
        find any branch using branch-name;  
        reconnect account to account-branch;  
      end  
    find next account within depositor;  
  end
```



DBTG Set-Processing Facility (Cont.)

- A newly created member record of type <record type> of a set type <set-type> can be added to a set occurrence either explicitly (manually) or implicitly (automatically).
- Specify the insert mode at set-definition time via
insertion is <insert mode>
 - **manual:** **connect** <record type> **to** <set-type>
 - **automatic:** **store** <record type>





Set Insertion Example

- Create account A535 for customer Hayes at the Downtown branch.
- Set insertion is **manual** for set type *depositor* and is **automatic** for set type *account-branch*.

```
branch.branch-name := "Downtown";  
find any branch using branch-name;  
account.account-number := "A-535";  
account.balance := 0;  
store account;  
customer.customer-name := "Hayes";  
find any customer using customer-name;  
connect account to depositor;
```



DBTG Set-Processing Facility (Cont.)

- Restrictions on how and when a member record can be removed from a set occurrence are specified at set-definition time via

retention is <retention-mode>

- <retention-mode> can take one of the three forms:
 1. **fixed** — a member record cannot be removed. To reconnect a record to another set, we must erase that record, recreate it, and then insert it into the new set occurrence.
 2. **mandatory** — a member record of a particular set occurrence can be reconnected to another set occurrence of only type <set-type>.
 3. **optional** — no restrictions on how and when a member record can be removed from a set occurrence.





DBTG Set-Processing Facility (Cont.)

- The best way to delete a record that is the owner of set occurrence of type `<set-type>` depends on the specification of the set retention of `<set-type>`.
- **optional** — the record will be deleted and every member of the set that it owns will be disconnected. These records, however, will be in the database.
- **fixed** — the record and all its owned members will be deleted; a member record cannot be removed from the set occurrence without being deleted.
- **mandatory** — the record cannot be erased, because the mandatory status indicates that a member record must belong to a set occurrence. The record cannot be disconnected from that set.



Set Ordering

Set ordering is specified by a programmer when the set is defined:

order is `<order-mode>`

- **first.** A new record is inserted in the first position; the set is in reverse chronological ordering.
- **last.** A new record is inserted in the final position; the set is in chronological ordering.
- **next.** Suppose that the currency pointer or `<set-type>` points to record *X*.
 - If *X* is a member type, a new record is inserted in the next position following *X*.
 - If *X* is an owner type, a new record is inserted in the first position.





Set Ordering (Cont.)

- **prior.** If X is a member type, a new record is inserted in the position just prior to X . If X is an owner type, a new record is inserted in the last position.
- **system default.** A new record is inserted in an arbitrary position determined by the system.
- **sorted.** A new record is inserted in a position that ensures that the set will remain sorted. The sorting order is specified by a particular key value when a programmer defines the set.
- **Example:** Consider the set occurrence of type *depositor* with the owner-record customer Turner and member-record accounts A-305, A-402, and A-408 ordered as indicated in our example schema (page A.14).



Set Ordering Example

- Add a new account A-125. For each <order-mode> option, the new set ordering is as follows:
- **first:** {A-125,A-305,A-402,A-408}
- **last:** {A-305,A-402,A-408,A-125}
- **next:** Suppose that the currency pointer points to record "Turner"; then the new set order is {A-125,A-305,A-402,A-408}
- **prior:** Suppose that the currency pointer points to record A-402; then the new set order is {A-305,A-125,A-402,A-408}
- **system default:** Any arbitrary order is acceptable; thus, {A-305,A-402,A-125,A-408} is a valid set ordering
- **sorted:** The set must be ordered in ascending order with account number being the key; thus, the ordering must be {A-125,A-305,A-402,A-408}





Mapping of Networks to Files

- We implement links by adding *pointer fields* to records that are associated via a link
- Each record must have one pointer field for each link with which it is associated.
- Example data-structure diagram and corresponding database.

Figure missing



Mapping of Networks to Files (Cont.)

- Diagram showing the sample instance with pointer fields to represent the links. Each link is replaced by two pointers.

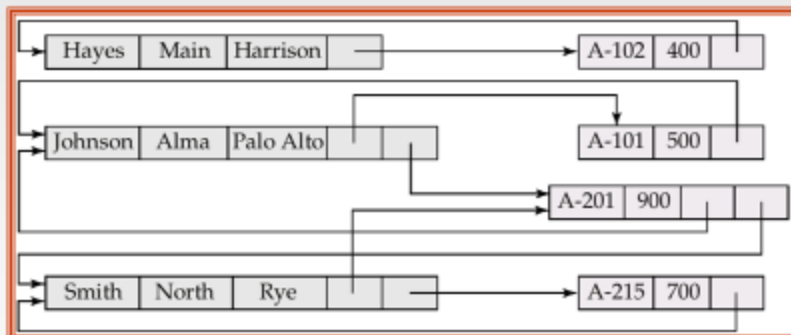



Mapping of Networks to Files (Cont.)

- Since the *depositor* link is many to many, each record can be associated with an arbitrary number of records (e.g., the *account* record would have a pointer to the *customer* record for each customer who has that account).
- Direct implementation of many-to-many relationships requires the use of variable length records.
- The DBTG model restricts links to be either one to one or one to many; the number of pointers needed is reduced, and it is possible to retain fixed-length records.



Mapping of Networks to Files (Cont.)

- Because an *account* record can be associated with only one *customer* record, we need only one pointer in the *account* record to represent the *depositor* relationship.
- A *customer* record can be associated with many *account* records.
- Rather than using multiple pointers in the *customer* record, we can use a *ring structure* to represent the entire occurrence of the DBTG set *depositor*.
- In a ring structure, the records of both the owner and member types for a set occurrence are organized into a circular list.
- There is one circular list for each set occurrence (that is, for each record of the owner type).





Example Ring Structure

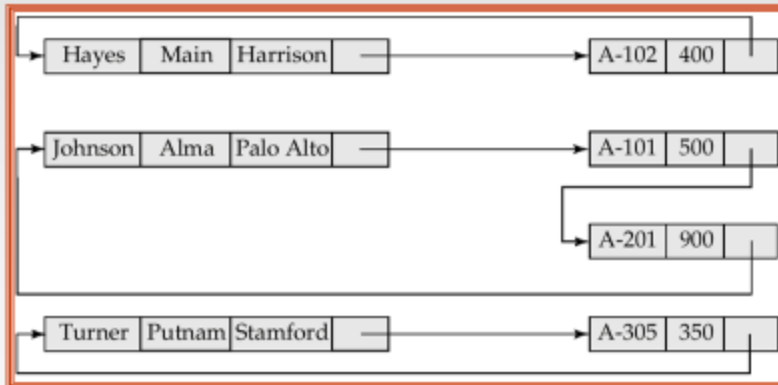

Modified Ring Structures

- Execute **find owner** via a ring structure in which every member-type record contains a second pointer which points to the owner record.

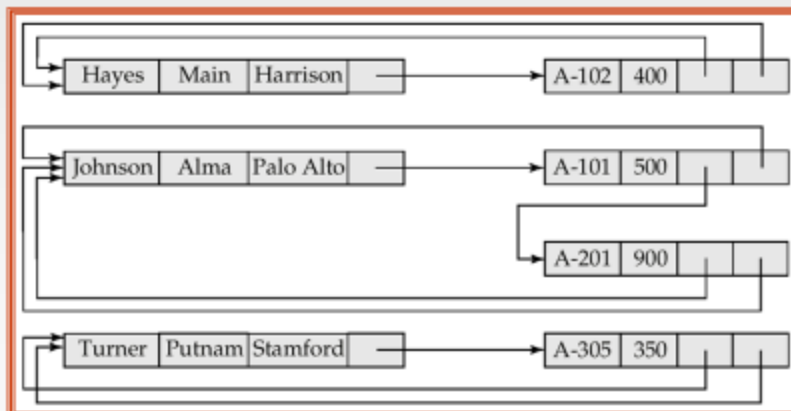



Physical Placement of Records

- To specify the storage strategy for DBTG set, add a **placement** clause to the definition of the member record type.
- The clause

placement clustered via depositor

will store members of each set occurrence close to one another physically on disk, if possible, in the same block.

- Store owner and member records close to one another physically on disk by adding the clause **near owner**.

placement clustered via depositor near owner



Physical Placement of Records (Cont.)

- Storing member records in the same block as the owner reduces the number of block accesses required to read an entire set occurrence.

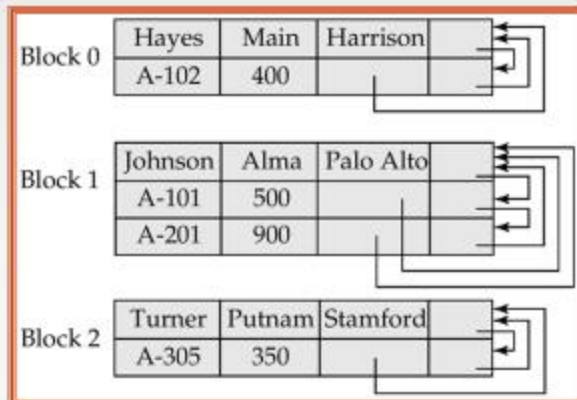



Sample Database

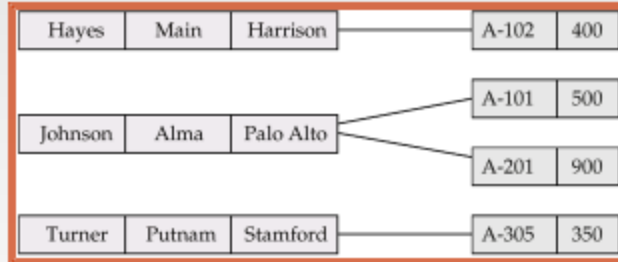

Two Data-Structure Diagrams

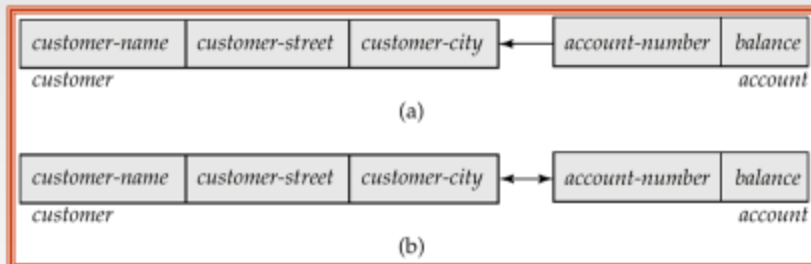



Sample Database Corresponding to Diagram of Figure A.3b

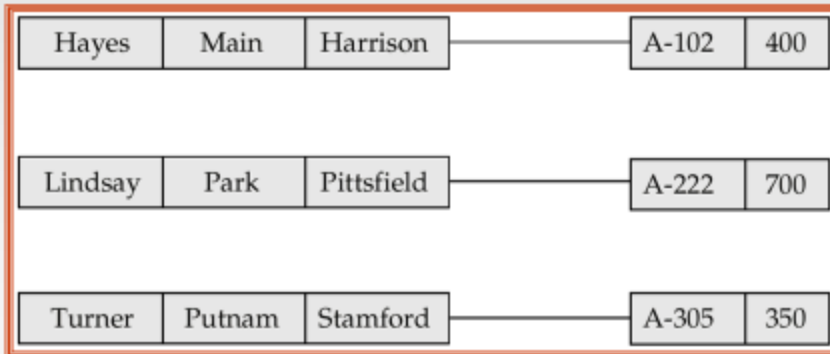

Sample Database Corresponding to Diagram of Figure A.6b

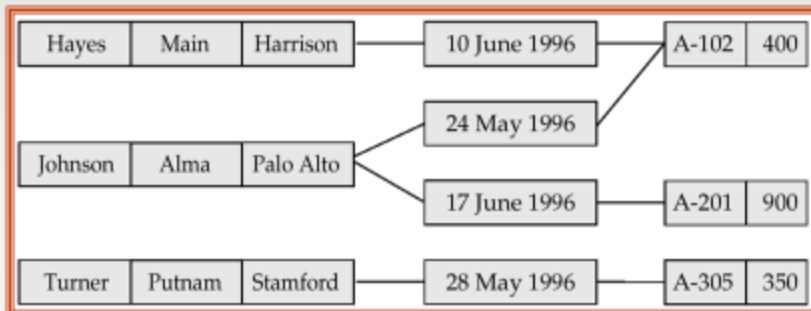



Sample Database Corresponding to Diagram of Figure A.8b

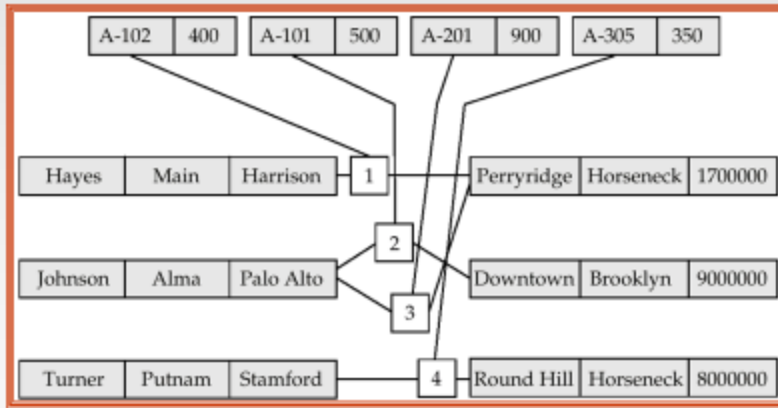

Two Data-Structure Diagrams

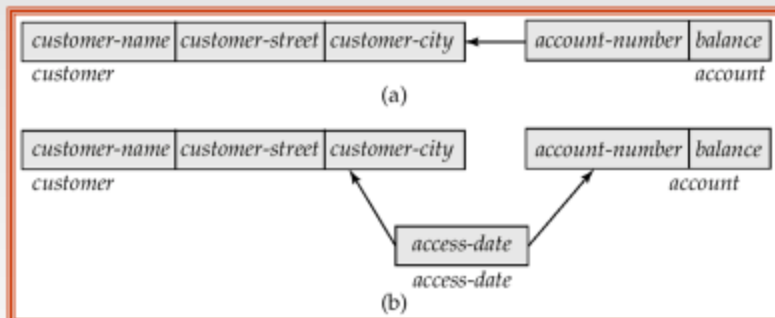



Sample Database Corresponding to the Diagram of Figure A.11

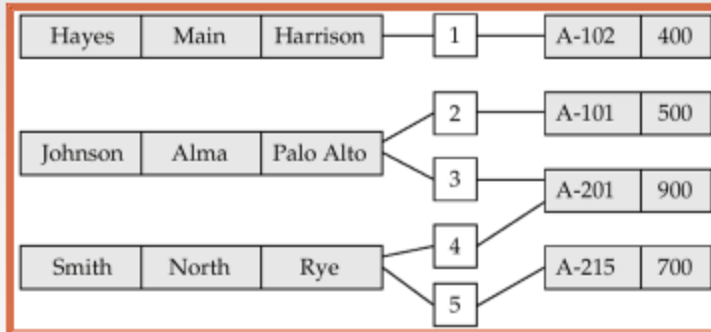

DBTG Set

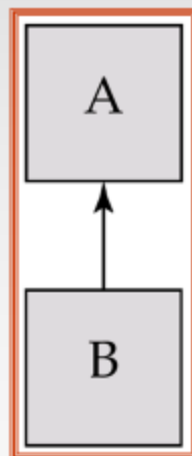



Three Set Occurrences

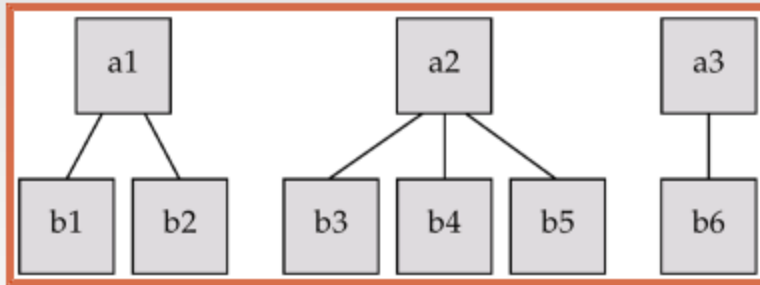

Data-Structure and E-R Diagram

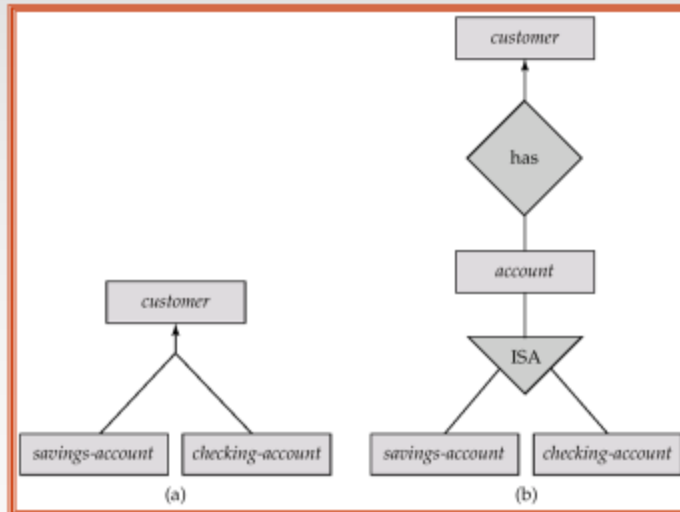



A customer Record

Turner	Putnam	Stamford
	Field	Horseneck



Clustered Record Placement for Instance for Figure A.1

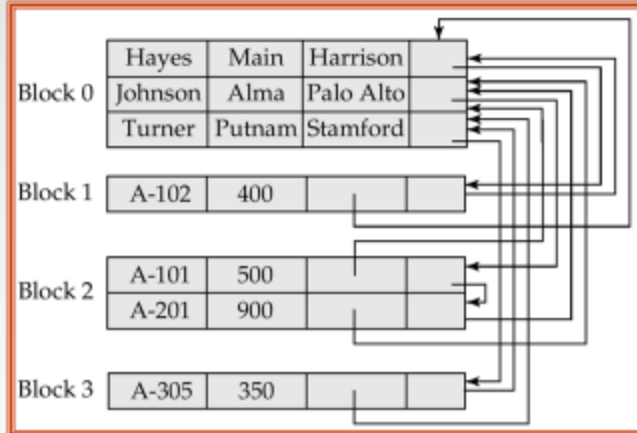



Class Enrollment E-R Diagram

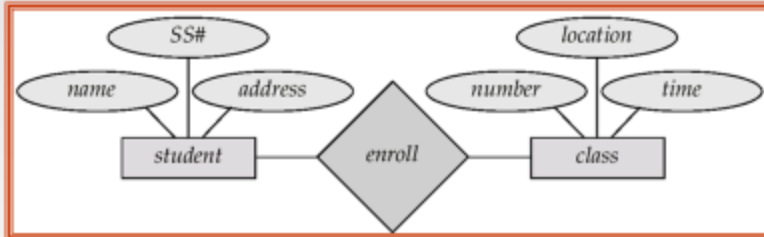

Parent—Child E-R Diagram

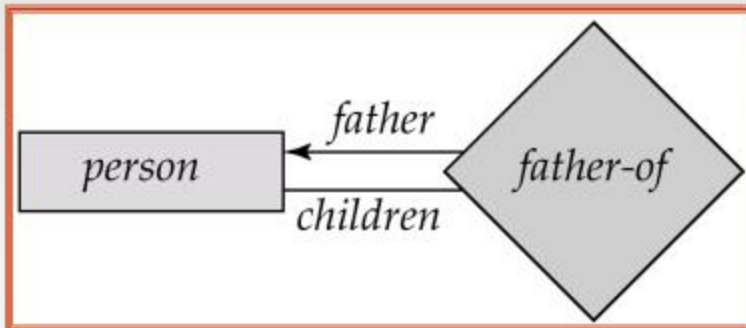



Car-Insurance E-R Diagram

